



PULEGGE TRAPEZOIDALI PER BUSSOLA CONICA

V-Belt pulleys for taper bushes
Keilriemenscheiben für Spannbuchsen
Poulies trapézoïdales à moyeu amovible
Poleas trapezoidales para casquillos conicos

Pulegge trapezoidali per bussola conica / V-Belt pulleys for taper bushes Keilriemenscheiben für Spannbuchsen / Poulies trapézoïdales à moyeu amovible Poleas trapezoidales para casquillos conicos

Le pulegge per cinghie trapezoidali presentate dalla SATI nel presente catalogo sono tutte costruite secondo le tabelle ISO 4183 e DIN 2211-3.

Il materiale impiegato nella costruzione delle medesime è in ghisa EN-GJL-200 UNI EN 1561 e, successivamente alle lavorazioni meccaniche, subiscono un trattamento superficiale di FOSFATAZIONE.

Tutte le pulegge sono equilibrate STATICAMENTE ed idonee ad un funzionamento fino alla velocità periferica di 35 m/s.

La gamma proposta nel seguente catalogo, comprende: PULEGGE TRAPEZOIDALI, per bussola conica, serie ZT..... AT..... BT..... CT..... PULEGGE TRAPEZOIDALI monoblocco (con mozzo pieno) serie ZM..... AM..... BM..... CM..... PULEGGE TRAPEZOIDALI per calettatore.

V-belt pulleys proposed by SATI in this catalogue are all manufactured according to ISO 4183 and DIN 2211-3 norms.

The material used for the construction of these pulleys is cast iron EN-GJL-200 UNI EN 1561 and after the machining all pulleys are being PHOSPHATED.

All pulleys are STATICALLY balanced and suitable for peripheral speed up to 35 m/s.

The range proposed in this catalogue is the following:
V-BELT PULLEYS for taper bush, series ZT..... AT..... BT..... CT.....
V-BELT PULLEYS with solid hub, series ZM..... AM..... BM..... CM.....
V-BELT PULLEYS for locking devices.

Die Keilriemenscheiben, die von SATI in diesem Katalog dargestellt sind, sind alle nach ISO 4183 und DIN 2211-3 hergestellt worden.

Das fuer die Produktion verwendete Material ist Grauguss EN-GJL-200 UNI EN 1561 und nach der Bearbeitung werden alle Keilriemenscheiben PHOSPHATIERT.

Alle Keilriemenscheiben sind STATISCH ausgewuchtet und fuer eine peripherische Betriebsgeschwindigkeit bis 35 m/s.

Die in diesem Katalog angegebene Palette ist die folgende: KEILRIEMENSCHLEIBEN fuer Spannbuchse, Serie ZT..... AT..... BT..... CT..... KEILRIEMENSCHLEIBEN ungebohrt, Serie ZM..... AM..... BM..... CM..... KEILRIEMENSCHLEIBEN fuer Spannsätze.

Les poulies trapézoïdales presentées par la SATI sur ce catalogue sont toutes fabriquées suivant les normes ISO 4183 et DIN 2211-3.

Le materiel utilisé pour la fabrication des poulies est la fonte EN-GJL-200 UNI EN 1561 et après l'usinage elles sont toutes exposées à un traitement de PHOSPHATATION.

Toutes les poulies sont équilibrées STATIQUEMENT et propres à tourner à une vitesse périphérique jusqu'à 35 m/s.

La gamme proposée dans ce catalogue est la suivante: POULIES TRAPEZOÏDALES pour moyeu amovible, série ZT..... AT..... BT..... CT..... POULIES TRAPEZOÏDALES à moyeu plein, série ZM..... AM..... BM..... CM..... POULIES TRAPEZOÏDALES pour à moyeu de serrage.

Las poleas para correas trapezoidales presentadas por la SATI en el presente catálogo están todas construidas según las tablas ISO 4183 y DIN 2211-3.

El material empleado en la construcción de las mismas es el hierro fundido EN-GJL-200 UNI EN 1561 y después de las elaboraciones mecánicas están sometidas a un tratamiento superficial de FOSFATAZIONE.

Todas las poleas están equilibradas ESTÁTICAMENTE y son adecuadas para un funcionamiento de una velocidad de hasta 35 m/s.

La gama propuesta en el siguiente catálogo comprende: POLEAS TRAPEZOIDALES para casquillos cónicos, serie ZT..... AT..... BT..... CT..... POLEAS TRAPEZOIDALES con cubo pleno, serie ZM..... AM..... BM..... CM..... POLEAS TRAPEZOIDALES para casquillos de fijación.

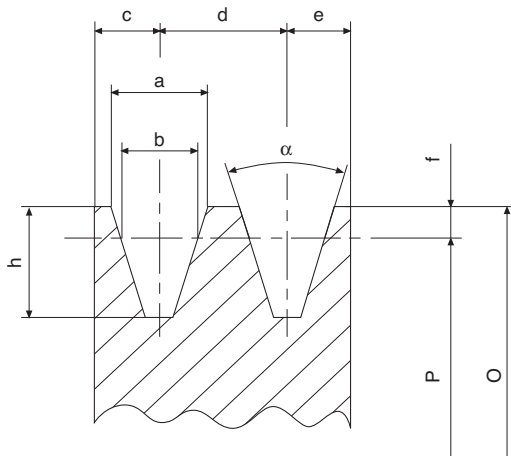

Calcolo della velocità periferica Vp in m/s
Calculation of peripheral speed Vp in m/s
Berechnung der Umfangsgeschwindigkeit Vp in m/s
Calcul de la vitesse périphérique Vp m/s
Cálculo de la velocidad periférica Vp en m/s

$$V_p = \frac{p \cdot P \cdot \text{rpm}}{60 \cdot 1000} @ \frac{P \cdot \text{rpm}}{19100} \quad V_p \leq 35 \text{ m/s}$$

P = Diametro primitivo in mm
Pitch diameter in mm
Teildurchmesser in mm
Diamètre primitif en mm
Diámetro primitivo en mm

rpm = Giri al minuto
Revolutions per minute
Umdrehungen pro Minute
Tours par minute
Revoluciones por minuto

Dimensioni puleggia Pulley dimintions Keilriemenscheibenabmessungen Dimensions poulie Dimensiones polea

	a	b	c	d	e	f	h	34°	38°
SPZ	9,7	8,5	8,0	12,0	8,0	2,0	11,0	P ≤ 80	P > 80
SPA	12,7	11,0	10,0	15,0	10,0	2,8	13,8	P ≤ 118	P > 118
SPB	16,3	14,0	12,5	19,0	12,5	3,5	17,5	P ≤ 190	P > 190
SPC	22,0	19,0	17,0	25,5	17,0	4,8	23,8	P ≤ 315	P > 315

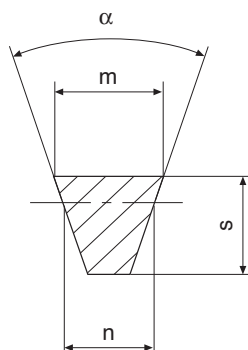

Dimensioni cinghia / Belt dimintions / Riemenabmessungen Dimensions courroie / Dimensiones correa

	m	s	n
SPZ	9,7	8	8,5
SPA	12,7	10	11,0
SPB	16,3	13	14,0
SPC	22,0	18	19,0

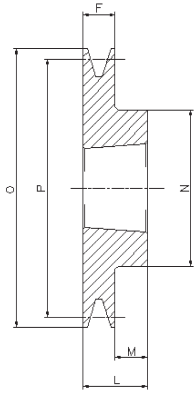

1

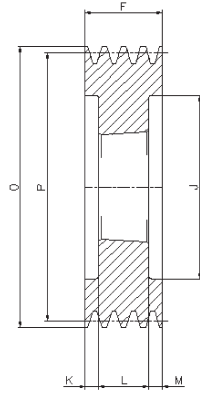

3

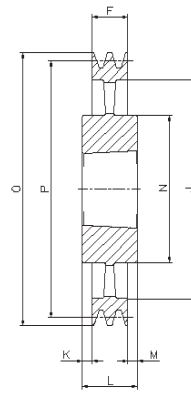

4

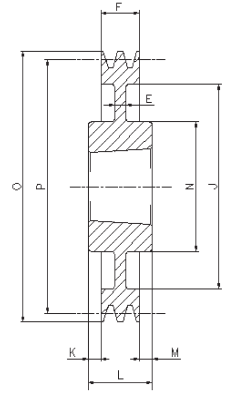

7

SPC/3

Cod. interno Internal code Intern Code Code interne Código interno	Tipo Type Typ Type Tipo	Gole Grooves Rillen Gorges Canales	P	O	Forma Form Forme Forme Forma	Bussola Bush Buchse Moyeu Casquillo	∅ MAX	E	F	J	K	L	M	N
CT02003	SPC200-03	3	200	209,6	3	2517	60	-	85	144	20,0	45	20,0	-
CT02123	SPC212-03	3	212	221,6	3	3020	75	-	85	156	17,0	51	17,0	-
CT02243	SPC224-03	3	224	233,6	3	3020	75	-	85	168	17,0	51	17,0	-
CT02363	SPC236-03	3	236	245,6	3	3020	75	-	85	180	17,0	51	17,0	-
CT02503	SPC250-03	3	250	259,6	3	3020	75	-	85	194	17,0	51	17,0	-
CT02653	SPC265-03	3	265	274,6	1	3535	90	-	85	209	-	89	4,0	175
CT02803	SPC280-03	3	280	289,6	1	3535	90	-	85	224	-	89	4,0	175
CT03003	SPC300-03	3	300	309,6	7	3535	90	20	85	244	2,0	89	2,0	175
CT03153	SPC315-03	3	315	324,6	7	3535	90	20	85	259	2,0	89	2,0	175
CT03353	SPC335-03	3	335	344,6	7	3535	90	20	85	279	2,0	89	2,0	175
CT03553	SPC355-03	3	355	364,6	7	3535	90	20	85	299	2,0	89	2,0	175
CT03753	SPC375-03	3	375	384,6	7	3535	90	25	85	319	2,0	89	2,0	175
CT04003	SPC400-03	3	400	409,6	7	3535	90	17	85	344	2,0	89	2,0	175
CT04253	SPC425-03	3	425	434,6	7	3535	90	17	85	369	2,0	89	2,0	175
CT04503	SPC450-03	3	450	459,6	4	3535	90	-	85	394	2,0	89	2,0	175
CT04753	SPC475-03	3	475	484,6	4	3535	90	-	85	419	2,0	89	2,0	175
CT05003	SPC500-03	3	500	509,6	4	3535	90	-	85	444	2,0	89	2,0	175
CT05303	SPC530-03	3	530	539,6	4	3535	90	-	85	474	2,0	89	2,0	175
CT05603	SPC560-03	3	560	569,6	4	3535	90	-	85	504	2,0	89	2,0	175
CT06303	SPC630-03	3	630	639,6	4	4040	100	-	85	574	8,5	102	8,5	210
CT07103	SPC710-03	3	710	719,6	4	4545	110	-	85	652	14,5	114	14,5	242
CT08003	SPC800-03	3	800	809,6	4	4545	110	-	85	737	14,5	114	14,5	242
CT10003	SPC1000-03	3	1000	1009,6	4	5050	125	-	85	937	21,0	127	21,0	267
CT12503	SPC1250-03	3	1250	1259,6	4	5050	125	-	85	1187	21,0	127	21,0	267

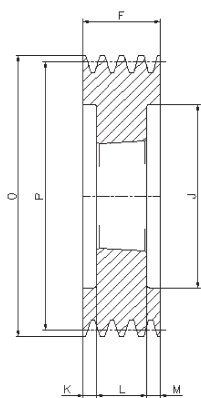

3

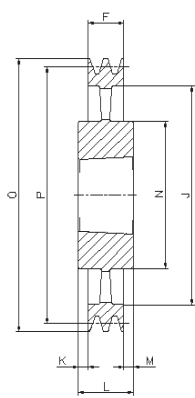

4

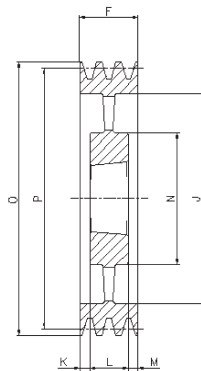

5

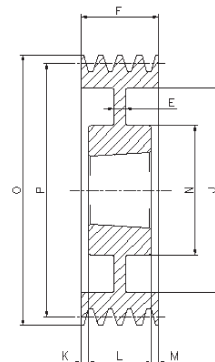

6

SPC/4

Cod. interno Internal code Intern Code Code interne Código interno	Tipo Type Typ Type Tipo	Gole Grooves Rillen Gorges Canales	P	O	Forma Form Forme Forme Forma	Bussola Bush Buchse Moyeu Casquillo	∅ MAX	E	F	J	K	L	M	N
CT02004	SPC200-04	4	200	209,6	3	3020	75	-	111	144	30,0	51	30,0	-
CT02124	SPC212-04	4	212	221,6	3	3020	75	-	111	156	30,0	51	30,0	-
CT02244	SPC224-04	4	224	233,6	3	3535	90	-	111	168	11,0	89	11,0	-
CT02364	SPC236-04	4	236	245,6	3	3535	90	-	111	180	11,0	89	11,0	-
CT02504	SPC250-04	4	250	259,6	3	3535	90	-	111	194	11,0	89	11,0	-
CT02654	SPC265-04	4	265	274,6	3	3535	90	-	111	209	11,0	89	11,0	-
CT02804	SPC280-04	4	280	289,6	6	3535	90	18	111	224	11,0	89	11,0	175
CT03004	SPC300-04	4	300	309,6	6	3535	90	20	111	244	11,0	89	11,0	175
CT03154	SPC315-04	4	315	324,6	6	3535	90	20	111	259	11,0	89	11,0	175
CT03354	SPC335-04	4	335	344,6	6	3535	90	20	111	279	11,0	89	11,0	175
CT03554	SPC355-04	4	355	364,6	6	3535	90	20	111	299	11,0	89	11,0	175
CT03754	SPC375-04	4	375	384,6	6	3535	90	25	111	319	11,0	89	11,0	175
CT04004	SPC400-04	4	400	409,6	6	3535	90	18	111	344	11,0	89	11,0	175
CT04254	SPC425-04	4	425	434,6	6	3535	90	18	111	369	11,0	89	11,0	175
CT04504	SPC450-04	4	450	459,6	5	3535	90	-	111	394	11,0	89	11,0	175
CT04754	SPC475-04	4	475	484,6	5	3535	90	-	111	419	11,0	89	11,0	175
CT05004	SPC500-04	4	500	509,6	5	3535	90	-	111	444	11,0	89	11,0	175
CT05304	SPC530-04	4	530	539,6	5	4040	100	-	111	474	4,5	102	4,5	210
CT05604	SPC560-04	4	560	569,6	5	4040	100	-	111	504	4,5	102	4,5	210
CT06304	SPC630-04	4	630	639,6	4	4545	110	-	111	574	1,5	114	1,5	242
CT07104	SPC710-04	4	710	719,6	4	5050	125	-	111	654	8,0	127	8,0	267
CT08004	SPC800-04	4	800	809,6	4	5050	125	-	111	737	8,0	127	8,0	267
CT10004	SPC1000-04	4	1000	1009,6	4	5050	125	-	111	937	8,0	127	8,0	267
CT12504	SPC1250-04	4	1250	1259,6	4	5050	125	-	111	1187	8,0	127	8,0	267

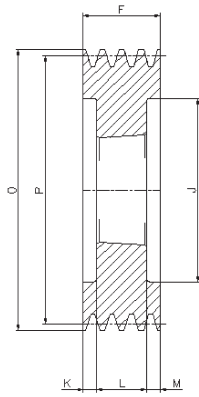

3

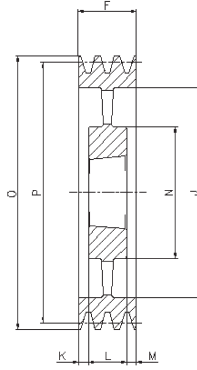

5

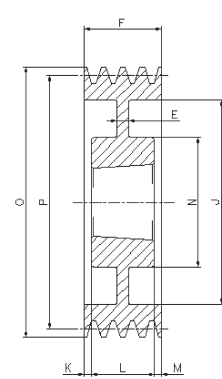

6

SPC/5

Cod. interno Internal code Intern Code Code interne Código interno	Tipo Type Typ Type Tipo	Gole Grooves Rillen Gorges Canales	P	O	Forma Form Forme Forme Forma	Bussola Bush Buchse Moyeu Casquillo	∅ MAX	E	F	J	K	L	M	N
CT02005	SPC200-05	5	200	209,6	3	3535	90	-	136	144	23,5	89	23,5	-
CT02125	SPC212-05	5	212	221,6	3	3535	90	-	136	156	23,5	89	23,5	-
CT02245	SPC224-05	5	224	233,6	3	3535	90	-	136	168	23,5	89	23,5	-
CT02365	SPC236-05	5	236	245,6	3	3535	90	-	136	180	23,5	89	23,5	-
CT02505	SPC250-05	5	250	259,6	3	3535	90	-	136	194	23,5	89	23,5	-
CT02655	SPC265-05	5	265	274,6	3	3535	90	-	136	209	23,5	89	23,5	-
CT02805	SPC280-05	5	280	289,6	3	3535	90	-	136	224	23,5	89	23,5	-
CT03005	SPC300-05	5	300	309,6	6	3535	90	20	136	244	23,5	89	23,5	175
CT03155	SPC315-05	5	315	324,6	6	3535	90	20	136	259	23,5	89	23,5	175
CT03355	SPC335-05	5	335	344,6	6	3535	90	20	136	279	23,5	89	23,5	175
CT03555	SPC355-05	5	355	364,6	6	3535	90	20	136	299	23,5	89	23,5	175
CT03755	SPC375-05	5	375	384,6	6	3535	90	25	136	319	23,5	89	23,5	175
CT04005	SPC400-05	5	400	409,6	6	3535	90	15	136	344	23,5	89	23,5	175
CT04255	SPC425-05	5	425	434,6	6	3535	90	20	136	369	23,5	89	23,5	175
CT04505	SPC450-05	5	450	459,6	5	4040	100	-	136	394	17,0	102	17,0	210
CT04755	SPC475-05	5	475	484,6	5	4040	100	-	136	419	17,0	102	17,0	210
CT05005	SPC500-05	5	500	509,6	5	4040	100	-	136	444	17,0	102	17,0	210
CT05305	SPC530-05	5	530	539,6	5	4545	110	-	136	474	11,0	114	11,0	240
CT05605	SPC560-05	5	560	569,6	5	4545	110	-	136	504	11,0	114	11,0	242
CT06305	SPC630-05	5	630	639,6	5	5050	125	-	136	574	4,5	127	4,5	267
CT07105	SPC710-05	5	710	719,6	5	5050	125	-	136	654	4,5	127	4,5	267
CT08005	SPC800-05	5	800	809,6	5	5050	125	-	136	737	4,5	127	4,5	267
CT10005	SPC1000-05	5	1000	1009,6	5	5050	125	-	136	937	4,5	127	4,5	267
CT12505	SPC1250-05	5	1250	1259,6	5	5050	125	-	136	1187	4,5	127	4,5	267

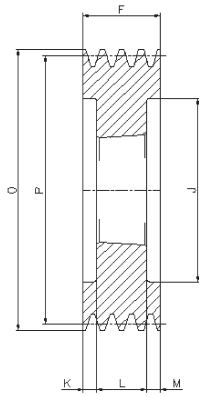

3

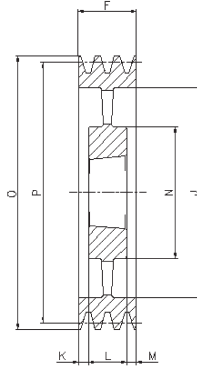

5

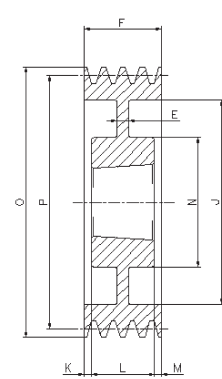

6

SPC/6

Cod. interno Internal code Intern Code Code interne Código interno	Tipo Type Typ Type Tipo	Gole Grooves Rillen Gorges Canales	P	O	Forma Form Forme Forme Forma	Bussola Bush Buchse Moyeu Casquillo	∅ MAX	E	F	J	K	L	M	N
CT02006	SPC200-06	6	200	209,6	3	3535	90	-	162	144	36,5	89	36,5	-
CT02126	SPC212-06	6	212	221,6	3	3535	90	-	162	156	36,5	89	36,5	-
CT02246	SPC224-06	6	224	233,6	3	3535	90	-	162	168	36,5	89	36,5	-
CT02366	SPC236-06	6	236	245,6	3	3535	90	-	162	180	36,5	89	36,5	-
CT02506	SPC250-06	6	250	259,6	3	3535	90	-	162	194	36,5	89	36,5	-
CT02656	SPC265-06	6	265	274,6	3	3535	90	-	162	209	36,5	89	36,5	-
CT02806	SPC280-06	6	280	289,6	6	3535	90	20	162	224	36,5	89	36,5	175
CT03006	SPC300-06	6	300	309,6	6	3535	90	20	162	244	36,5	89	36,5	175
CT03156	SPC315-06	6	315	324,6	6	3535	90	20	162	259	36,5	89	36,5	175
CT03356	SPC335-06	6	335	344,6	6	3535	90	20	162	279	36,5	89	36,5	175
CT03556	SPC355-06	6	355	364,6	6	3535	90	20	162	299	36,5	89	36,5	175
CT03756	SPC375-06	6	375	384,6	6	4040	100	30	162	319	30,0	102	30,0	210
CT04006	SPC400-06	6	400	409,6	6	4040	100	30	162	344	30,0	102	30,0	210
CT04256	SPC425-06	6	425	434,6	6	4040	100	30	162	369	30,0	102	24,0	210
CT04506	SPC450-06	6	450	459,6	6	4545	110	30	162	394	24,0	114	24,0	242
CT04756	SPC475-06	6	475	484,6	6	4545	110	30	162	419	24,0	114	24,0	242
CT05006	SPC500-06	6	500	509,6	5	4545	110	-	162	444	24,0	114	24,0	242
CT05306	SPC530-06	6	530	539,6	5	5050	125	-	162	474	17,5	114	17,5	265
CT05606	SPC560-06	6	560	569,6	5	5050	125	-	162	504	17,5	127	17,5	267
CT06306	SPC630-06	6	630	639,6	5	5050	125	-	162	574	17,5	127	17,5	267
CT07106	SPC710-06	6	710	719,6	5	5050	125	-	162	654	17,5	127	17,5	267
CT08006	SPC800-06	6	800	809,6	5	5050	125	-	162	737	17,5	127	17,5	267
CT10006	SPC1000-06	6	1000	1009,6	5	5050	125	-	162	937	17,5	127	17,5	267
CT12506	SPC1250-06	6	1250	1259,6	5	5050	125	-	162	1187	17,5	127	17,5	267

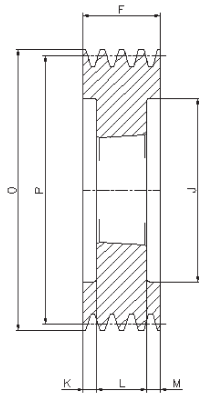

3

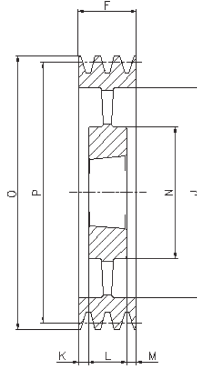

5

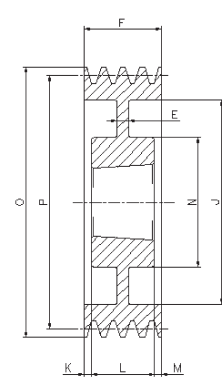

6

SPC/8

Cod. interno Internal code Intern Code Code interne Código interno	Tipo Type Typ Type Tipo	Gole Grooves Rillen Gorges Canales	P	O	Forma Form Forme Forme Forma	Bussola Bush Buchse Moyeu Casquillo	Ø MAX	E	F	J	K	L	M	N
CT02008	SPC200-08	8	200	209,6	3	3535	90	-	213	144	62,0	89	62,0	-
CT02128	SPC212-08	8	212	221,6	3	3535	90	-	213	156	62,0	89	62,0	-
CT02248	SPC224-08	8	224	233,6	3	3535	90	-	213	168	62,0	89	62,0	-
CT02368	SPC236-08	8	236	245,6	3	3535	90	-	213	180	62,0	89	62,0	-
CT02508	SPC250-08	8	250	259,6	3	3535	90	-	213	194	62,0	89	62,0	-
CT02658	SPC265-08	8	265	274,6	3	3535	90	-	213	209	62,0	89	62,0	-
CT02808	SPC280-08	8	280	289,6	3	3535	90	-	213	224	62,0	89	62,0	-
CT03008	SPC300-08	8	300	309,6	3	4040	100	-	213	244	55,5	102	55,5	-
CT03158	SPC315-08	8	315	324,6	3	4040	100	-	213	259	55,5	102	55,5	-
CT03358	SPC335-08	8	335	344,6	6	4040	100	50	213	279	55,5	102	55,5	210
CT03558	SPC355-08	8	355	364,6	6	4040	100	40	213	299	55,5	102	55,5	210
CT03758	SPC375-08	8	375	384,6	6	4545	110	30	213	319	49,5	114	49,5	242
CT04008	SPC400-08	8	400	409,6	6	4545	110	30	213	344	49,5	114	49,5	242
CT04258	SPC425-08	8	425	434,6	6	4545	110	30	213	369	49,5	114	49,5	240
CT04508	SPC450-08	8	450	459,6	6	5050	125	30	213	394	43,0	127	43,0	267
CT04758	SPC475-08	8	475	484,6	6	5050	125	30	213	419	43,0	127	43,0	267
CT04998	SPC500-08	8	500	509,6	6	5050	125	30	213	444	43,0	127	43,0	267
CT05308	SPC530-08	8	530	539,6	6	5050	125	30	213	474	43,0	127	43,0	267
CT05608	SPC560-08	8	560	569,6	5	5050	125	-	213	504	43,0	127	43,0	267
CT06308	SPC630-08	8	630	639,6	5	5050	125	-	213	574	43,0	127	43,0	267
CT07108	SPC710-08	8	710	719,6	5	5050	125	-	213	654	43,0	127	43,0	267
CT08008	SPC800-08	8	800	809,6	5	5050	125	-	213	737	43,0	127	43,0	267
CT09998	SPC1000-08	8	1000	1009,6	5	5050	125	-	213	937	43,0	127	43,0	267
CT12508	SPC1250-08	8	1250	1259,6	5	5050	125	-	213	1187	43,0	127	43,0	267

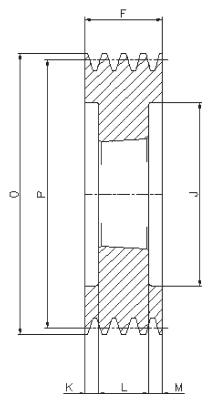

3

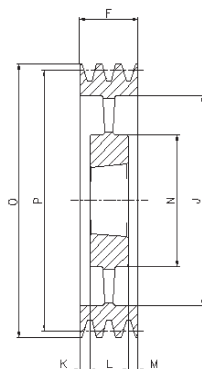

5

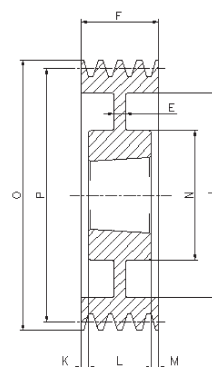

6

SPC/10

Cod. interno Internal code Intern Code Code interne Código interno	Tipo Type Typ Type Tipo	Gole Grooves Rillen Gorges Canales	P	O	Forma Form Forme Forme Forma	Bussola Bush Buchse Moyeu Casquillo	∅ MAX	E	F	J	K	L	M	N
CT0224X	SPC224-10	10	224	233,6	3	4040	100	-	264	170	81,0	102	81,0	-
CT0250X	SPC250-10	10	250	259,6	3	4040	100	-	264	194	81,0	102	81,0	-
CT0280X	SPC280-10	10	280	289,6	3	4040	100	-	264	224	81,0	102	81,0	-
CT0300X	SPC300-10	10	300	309,6	3	4545	110	-	264	244	75,0	114	75,0	-
CT0315X	SPC315-10	10	315	324,6	3	4545	110	-	264	259	75,0	114	75,0	-
CT0355X	SPC355-10	10	355	364,6	3	4545	110	-	264	299	75,0	114	75,0	-
CT0375X	SPC375-10	10	375	384,6	3	4545	110	-	264	316	75,0	114	75,0	-
CT0400X	SPC400-10	10	400	409,6	6	5050	125	70	264	344	68,5	127	68,5	267
CT0450X	SPC450-10	10	450	459,6	6	5050	125	40	264	394	68,5	127	68,5	267
CT0500X	SPC500-10	10	500	509,6	6	5050	125	40	264	444	68,5	127	68,5	267
CT0560X	SPC560-10	10	560	569,6	5	5050	125	-	264	504	68,5	127	68,5	267
CT0630X	SPC630-10	10	630	639,6	5	5050	125	-	264	574	68,5	127	68,5	267
CT0710X	SPC710-10	10	710	719,6	5	5050	125	-	264	654	68,5	127	68,5	267
CT0800X	SPC800-10	10	800	809,6	5	5050	125	-	264	737	68,5	127	68,5	267
CT1000X	SPC1000-10	10	1000	1009,6	5	5050	125	-	264	937	68,5	127	68,5	267
CT1250X	SPC1250-10	10	1250	1259,6	5	5050	125	-	264	1187	68,5	127	68,5	267